

Work happily



V1.0

naggura'swop

naggura.com

# I nostri prodotti

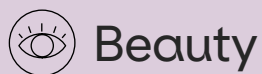

S502WHITE



S502GREY



La SWOP 502 è un lettino elettrico di 4 motori con un'ottima stabilità e un telaio ultra compatto.

Legno, Metallo o Pmma

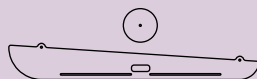

# Collezioni

Nordic  
METALLO

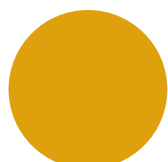

Yellow

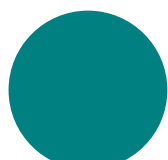

Blue

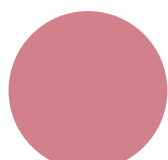

Pink

Foll  
METALLO



Ash

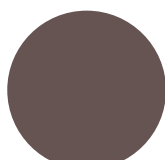

Clay

Iron  
METALLO

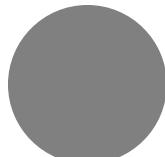

Inox

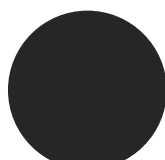

Black

Om  
LEGNO



Oak



Wenge

Techno  
PMMA



Fluor



Fuxia



Ice

# S502

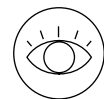

## Dimensioni

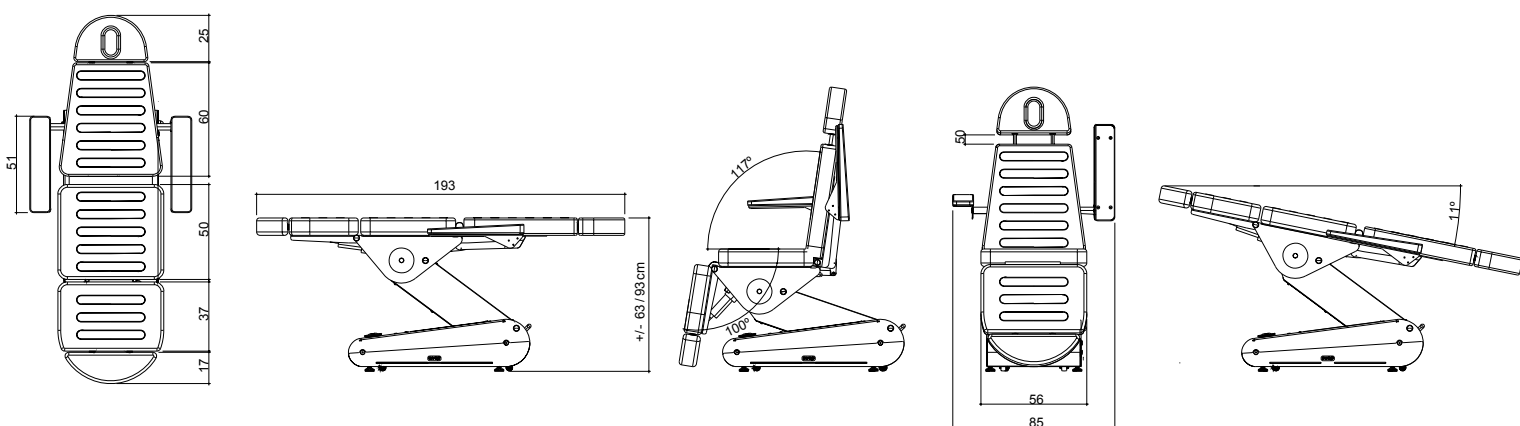

## Caratteristiche tecniche

MOTORI  
4 motori

DIMENSIONI (LUNGHEZZA X LARGHEZZA)  
193 x 85 cm

ALTEZZA (MINIMA E MASSIMA)  
63/93 cm

PESO  
105 kg

SPESORE  
10 cm

DENSITÀ  
30 kg/m<sup>3</sup>

CAPACITÀ DI CARICO  
175 kg

FUNZIONAMENTO  
Telecomando (incluso)/  
Pedaliera (opzionale)

ALIMENTAZIONE ELETTRICA  
230 V - 50/60 Hz

POTENZA MASSIMA  
2 A

MOTORE ELETTRICO  
6.000 N

RIVESTIMENTO

100% composto di vinilico

Permablok 3 Advanced Vinyl Protection (contro i germi e l'abrasione), resistente ai raggi UV, resistenza superiore 300K, colore grigio

Permaguard Advanced Vinyl Protection (contro i germi e l'abrasione), resistente ai raggi UV, abrasione 100K, colore bianco